

MULTIPROP

Cost-effective for use both as a lightweight slab prop and shoring tower

Product brochure



Contents

System advantages		System overview	
3	MULTIPROP	10	MULTIPROP at a glance
4	High load-bearing capacity		
6	Well thought-out details		
7	Time-saving length adjustment	12	Accessories Fast and safe working operations with MULTIPROP
8	Practical wedge connection		
			Logistics
		16	Safer and faster transport

Edition 04 | 2016

Publisher

PERI GmbH
Formwork Scaffolding Engineering
Rudolf-Diesel-Strasse 19
89264 Weissenhorn
Germany
Tel. +49 (0)7309.950-0
Fax +49 (0)7309.951-0
info@peri.com
www.peri.com

17	Project examples Project examples with MULTIPROP
----	---

20	Components MULTIPROP components
----	---

Important notes

All current safety regulations and guidelines must be observed in those countries where our products are used.

The photos shown in this brochure feature construction sites in progress. For this reason, safety and anchor details in particular cannot always be considered as conclusive or final. These are subject to the risk assessment carried out by the contractor.

In addition, computer graphics are used which are to be understood as system representations. For ensuring a better understanding, these and the detailed illustrations shown have been partially

reduced to certain aspects. The safety installations which have possibly not been shown in these detailed descriptions must nevertheless be available.

The systems or items shown might not be available in every country.

Safety instructions and load specifications are to be strictly observed at all times. Separate structural calculations are required in case of changes and deviations.

The information contained herein is subject to technical changes in the interests of progress. Errors and typographical mistakes reserved.

PERI SKYDECK

PERI SKYDECK

PERI SKYDECK

PERI SKYDECK

PERI SKYDECK

PERI SKYDECK

PERI SKYDECK

PERI SKYDECK

PERI SKYDECK

PERI SKYDECK

PERI SKYDECK

PERI SKYDECK

PERI SKYDECK

PERI SKYDECK

PERI SKYDECK

PERI SKYDECK

PERI SKYDECK

PERI SKYDECK

PERI SKYDECK

PERI SKYDECK

PERI SKYDECK

PERI SKYDECK

PERI SKYDECK

PERI SKYDECK

PERI SKYDECK

PERI SKYDECK

PERI SKYDECK

PERI SKYDECK

PERI SKYDECK

PERI SKYDECK

PERI SKYDECK

PERI SKYDECK

PERI SKYDECK

PERI SKYDECK

PERI SKYDECK

PERI SKYDECK

PERI SKYDECK

PERI SKYDECK

PERI SKYDECK

PERI SKYDECK

PERI SKYDECK

PERI SKYDECK

PERI SKYDECK

PERI SKYDECK



MULTIPROP

Cost-effective for use both as a lightweight slab prop and shoring tower

MULTIPROP Slab Props are used as individual props and – in combination with MULTIPROP Frames – as shoring towers. Compared with steel tube slab props, aluminium MULTIPROPs carry significantly higher loads (up to 90 kN) while at the same time having a very low deadweight. Through a range of different frame sizes, square and rectangular-shaped shoring towers can be optimally adapted to suit construction site conditions. The frames also serve as decking support and side protection for working levels.

MULTIPROP Props are made of aluminium and are therefore extremely light. The low weight is a decisive factor for ensuring easy and simple handling. With an extension length from 1.95 m to 3.50 m, the MP 350 covers 90% of standard operations in building construction. Weighing only 19.40 kg, the MP 350 can easily be set up and installed by one person, also when fully extended.

In addition, cleverly devised details such as the integrated measuring tape or the self-cleaning thread provide for quick and safe working operations.

The outer tubes of the MULTIPROP Slab Props are powder coated which makes the surfaces resistant to concrete adhesion. A long service life is ensured through the materials used as well as the design.

High load-bearing capacity

Fewer individual props per m² through permissible leg loads of up to 90 kN (according to approval)

Well thought-out details

With a self-cleaning thread, trendsetting adjusting collar and continuous adjustability

Time-saving length adjustment

The integrated measuring tape on the inner tube directly shows the complete length of the prop

Practical wedge connection

Multifunctional MRK Frame without any time-consuming bolted connections



High load-bearing capacity

Fewer individual props per m² through high leg loads



In drop tests on a transversely positioned steel tube, an extended MULTIPROP Prop remains completely undamaged – in contrast to, e.g. tubular steel props.

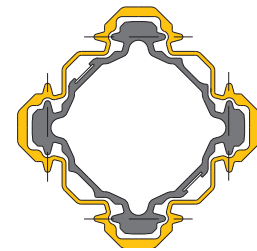

Corresponding axes in the profiles allow the frame to be connected to both the inner and outer tubes while maintaining the same prop grid arrangement.

MULTIPROP is lightweight and, at the same time, has a very high load-bearing capacity. The props carry leg loads up to 90 kN (according to approval).

The construction of the MULTIPROP Prop stands as an excellent example for optimized material utilization. A well thought-out design provides the MULTIPROP Prop with a particularly high load-bearing capacity and offers the best connection possibilities for accessories. In addition, the cleverly devised aluminium alloy profile elastically absorbs all impacts. As a result, the profile remains undamaged even if the prop, for example, falls over.

	Lengths	Weight	Max. load-bearing capacity
MP 120	0.80 m – 1.20 m	10.20 kg	up to 90.0 kN
MP 250	1.45 m – 2.50 m	15.40 kg	up to 78.5 kN
MP 350	1.95 m – 3.50 m	19.40 kg	up to 91.0 kN
MP 480	2.60 m – 4.80 m	24.80 kg	up to 88.5 kN
MP 625	4.30 m – 6.25 m	34.60 kg	up to 57.9 kN



Reducing the number of props is an essential step in order to minimize the cost values for the forming of slabs. MULTIPROP Props make a significant contribution with their high load-bearing capacities.

Furthermore, fewer slab props also ensure more free movement under the slab formwork. This facilitates in particular the transverse transportation of materials.



As an individual prop and braced with MULTIPROP MRK frames, the MULTIPROP Prop carries up to 90 kN per leg. Thus, MULTIPROP is also ideal for the re-shoring of slabs.



When used with SKYDECK Slab Formwork – shown here after a successful early striking – only 1 MULTIPROP Prop per 3.45 m² of slab area is required for a slab thickness up to 43 cm.



Particularly during refurbishment projects or modification work, MULTIPROP Slab Props allow working without a crane. They are easily transported and positioned by hand.

Well thought-out details

Self-cleaning thread and continuous adjustability

Cleverly developed detailed solutions for a very long service life. The continuous multiple thread of the MULTIPROP is self-cleaning and the free running collar does not jam even when the thread is dirty.

The free running collar makes adjustments very simple. One turn of the free running collar equals an adjustment distance of 36 mm – and thus 3 times more than for conventional slab props. The prop itself can still be continuously re-adjusted by means of the adjusting nut even when partially loaded up to 15 kN.



The design of the impact cam on the adjusting nut provides the direction, which is hit using a hammer in order to release the load.



Also when using the prop with the inner tube positioned below, the impact direction for releasing the adjusting nut is clearly visible.



With the Wing Nut Spanner HD, loads over 60 kN can also be reliably spindled load-free.



A self-cleaning thread and ECC powder coating make the MULTIPROP resistant to concrete adhesion.

Time-saving length adjustment

With an integrated measuring tape on the inner tube

Labour costs are a decisive factor for the economic success regarding the execution of the construction work. MULTIPROP supports fast working operations – among other things through exact height adjustments with very little time and effort.

The integrated measuring tape on the inner tube of the MULTIPROP Prop allows precise and fast pre-adjustment of the prop without any time-consuming measuring and unnecessarily long re-adjustment procedure. This solution is self-explanatory and requires no tools.

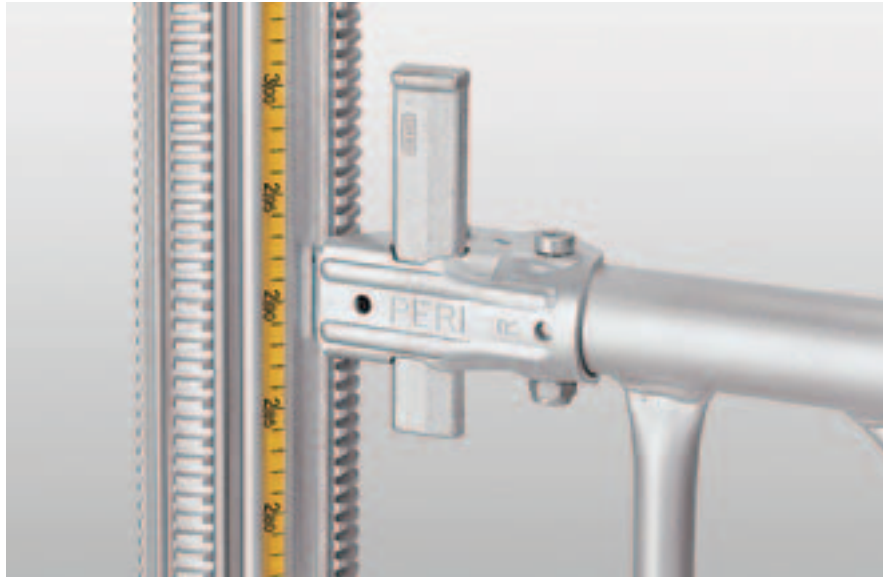

Working safety

Every MULTIPROP Prop can be continuously adjusted both quickly and safely, i.e. without re-inserting any pins. An integrated stopper prevents the inner tube from being accidentally pulled beyond the maximum system length.

Rationalization and working safety complement each other

In various work studies, the principle of the free running collar was compared to the locking pin system of conventional slab props.

Result:

The average time required for adjusting the MULTIPROP 350 is 25% less than for the locking pin principle. The large adjustment range of 36 mm per turn increases this effect even further.

Practical wedge connection

Multifunctional MRK Frame without time-consuming screw connections



For the erection of a shoring tower MULTIPROP Frames are connected to the MULTIPROP Props by means of the captive Wedge Coupler. The attachment of the MRK Frame is possible on both the outer as well as inner tube without having any effect on the ground plan.

The profile of the MULTIPROP facilitates quick and easy connections of the MRK Frames. The wedge of the frame is easily secured in position with a hammer; special tools or even bolted connections are not required. Pre-assembly of the MULTIPROP towers is usually carried out horizontally on the ground.

The high level of cost efficiency of the MULTIPROP Shoring Towers also results from the 12 different frame sizes. These facilitate optimum site-related ground plan adjustment with high utilization of the individual components.

Steel MRK Frame sizes

62.5 cm, 75 cm, 90 cm, 120 cm, 137.5 cm and 150 cm

Aluminium MRK Frame sizes

201.5 cm, 225 cm, 230 cm, 237 cm, 266 cm and 296 cm



MP Shoring Towers are type-tested up to heights of 14.40 m (14.90 m with Base MP 50). Topped-up props may only be used as towers with MRK Frames as bracing.



The complete tower can be erected and moved as a complete unit with one crane lift.



MULTIPROP Shoring Towers for scaffolding a 20 m high, cantilevered structural slab.



Especially with large slab heights, MULTIPROP Shoring Towers are a cost-effective alternative to standard spatial load-bearing scaffold.



MULTIPROP Shoring Towers as sub-structures for project-specific slab tables.



With VARIODECK Tables, the MULTIPROP Props are fixed in their designated perpendicular positions by means of MRK Frames.

MULTIPROP at a glance

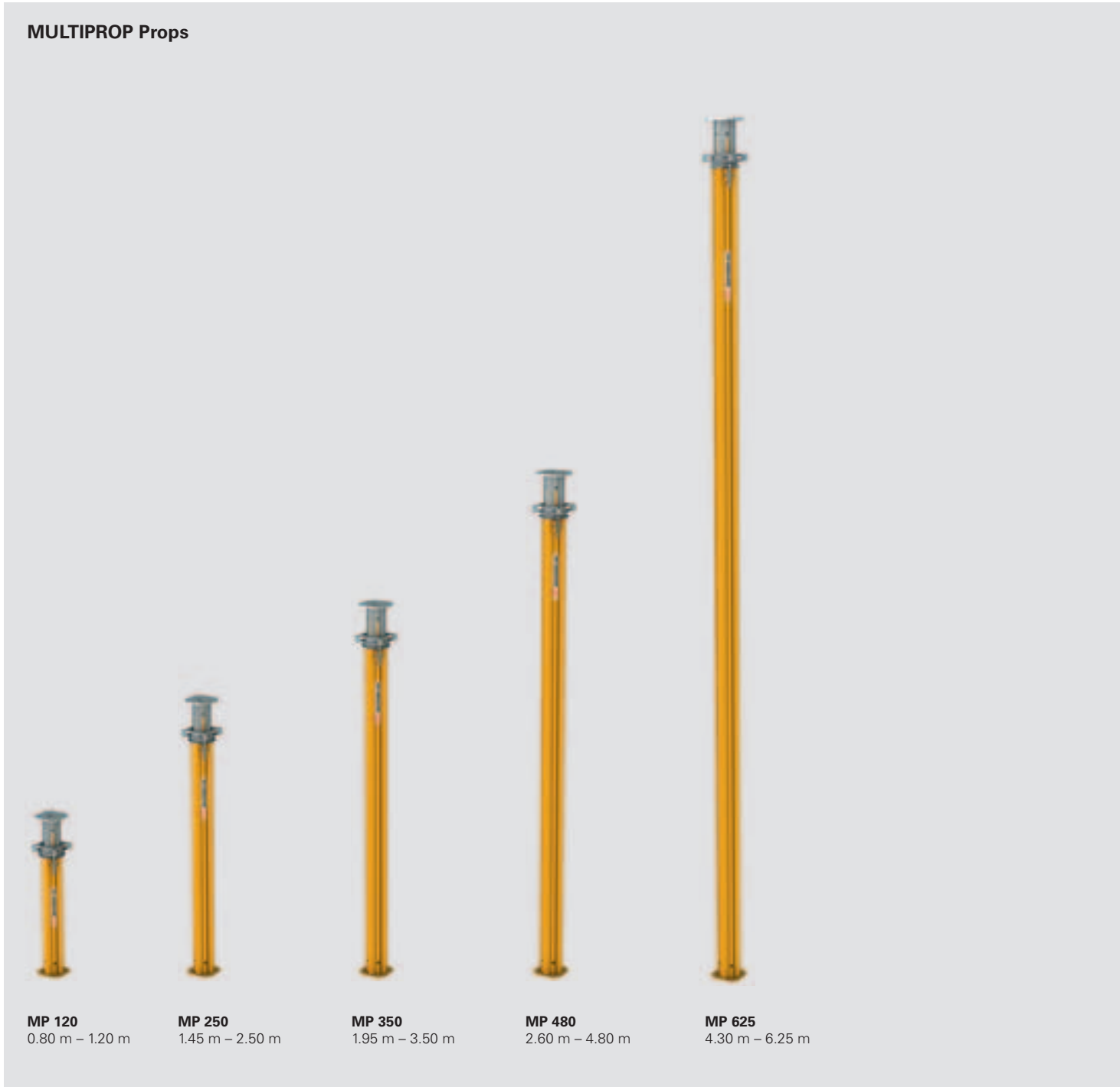

MULTIPROP Shoring Tower

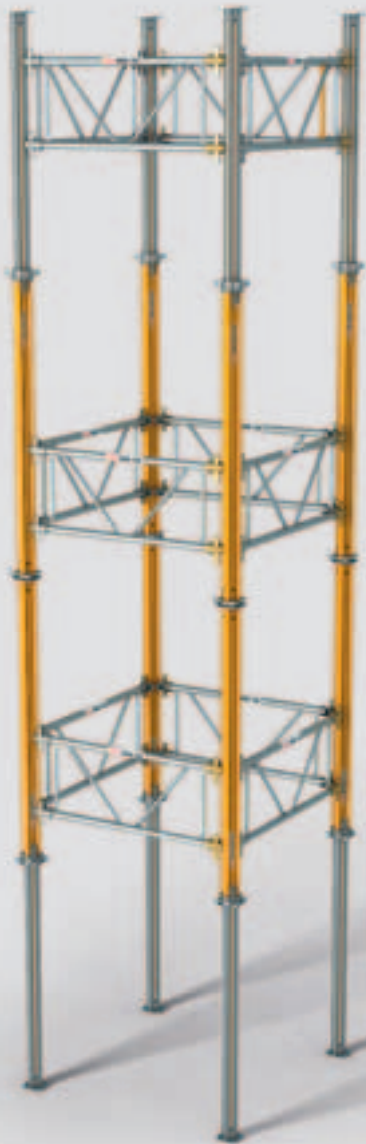

Type-tested assembly as shoring towers with Frames MRK up to heights of max. 14.40 m or 14.90 m with Base MP 50.



MULTIPROP Props MP 250, 350, 480 and 625 have general building approval from the German Institute of Building Technology in Berlin (Approval No. Z-8.312-824).

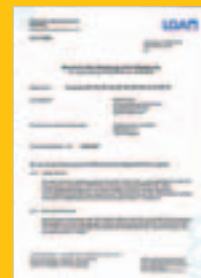

In the type test, over 70 assembly variations have been tested and certified by the Bavarian State Trade Institute (LGA) regarding their stability.

Fast and safe working operations with MULTIPROP

Universal Tripod



The Universal Tripod serves as a fast assembly aid and accommodates all props from Ø 48 mm to 120 mm.

Base MP 50

Increases prop "range of application" by 50 cm. With the clamped quick-release fastener, the Base MP 50 is mounted on the 10 mm thick end plate of the inner or outer tube with a few blows of a hammer. As a result, replacing props with longer or shorter ones when floor heights vary is often no longer required.

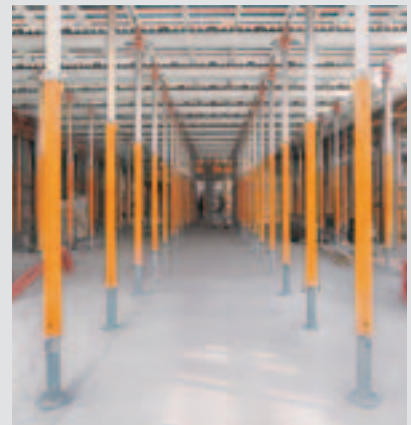

Compression Brace Head MP/SRU

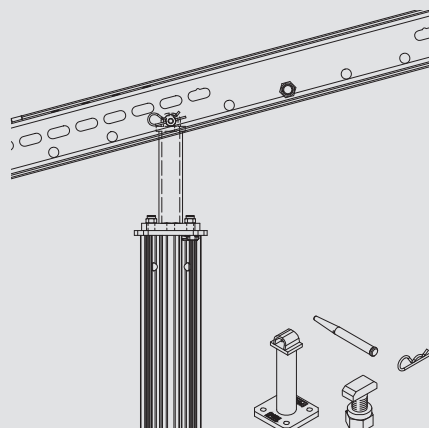

The Compression Brace Head MP/SRU is used for directly supporting SRU Main Beams. The connection of the prop and Brace Head by means of bolts and cotter pins allows any angle of inclination.

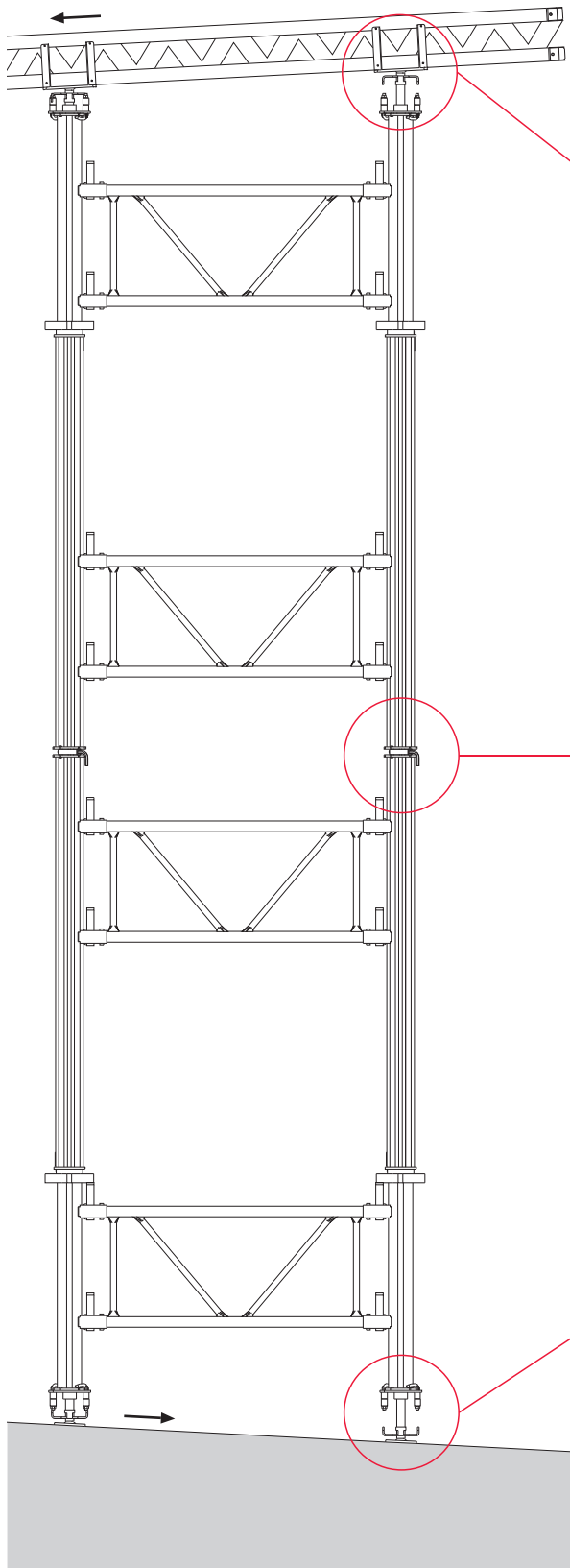

MULTIPROP Tilting Forkhead MKK

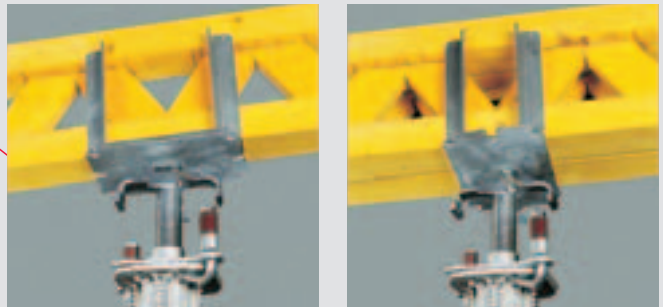

For secure and non-tilt acceptance of 1 or 2 GT 24 or VT 20 Girders. Can be pivoted on all sides by 3°. For use in MULTIPROP Shoring Towers.

MULTIPROP Connector MPV-2



For connecting 2 MULTIPROP Props to the outer or inner tubes. For use in MULTIPROP Shoring Towers.

MULTIPROP Tilting Base MKF



For use on inclined area levels, in connection with frames. Can be pivoted on all sides by 3°. For use in MULTIPROP Shoring Towers.

Fast and safe working operations with MULTIPROP

MULTIPROP Main Beam MPB 24



MULTIPROP towers with aluminium MPB Beams as main beams and GT 24 as decking support. Tilting Forkheads provide secure, non-tilting support for the beams.

Static values

Permissible bearing load	80 kN
Permissible bending moment	15 kN
Permissible shear force*	50 kN
Bending stiffness EI_y	1600 kNm ²

* for end support = permissible bearing load

With the high bearing load of 80 kN, the MPB 24 is the ideal primary beam for use with highly loaded MULTIPROP Shoring Towers. The large load-bearing capacity of MULTIPROP Props ensures a reduction in the required support. The

aluminium beam with lengths of 3.00 m, 4.20 m, 4.80 m, 5.40 m and 6.00 m can also be coupled together to form longer units by means of the MPB Connector.

Self-Locking Coupling

Various prop heads of PERI slab formwork can be very quickly and safely connected to the props with the self-locking coupling – without any time-consuming screws, bolts or wedges.

All prop heads with self-locking couplings of the PERI slab formwork systems fit to the MULTIPROP Slab Props.



Push-Pull Prop Connector

Fast connection of push-pull props to the MULTIPROP towers for providing temporary assembly support using only locking pins and cotter pins – independent of the selected prop connections.



MULTIPROP Decking

Decking with lengths of 150 cm and 225 cm – with and without access hatches for ladders respectively – allow the installation of shoring with assembly levels and access by means of telescopic ladders.

The decks are designed for maximum loads of 200 kg/m². In the process, MRK Frames not only serve as decking support for MULTIPROP Decks but also as fall protection (intermediate guardrail and handrail).



Safer and faster transport

With the right PERI transport containers and pallets, logistical operations are safer and faster.

The transport of materials in the yard and on the construction site causes considerable costs. In addition, loading and unloading, moving as well as putting into temporary storage poses a number of risks for workers.

PERI Pallets and Stacking Pallets are suitable for crane and forklift operations while clearly defined load-bearing points ensure safe transportation.

In one PERI Stacking Pallet RP 80 x 120, 25 MULTIPROP Props can be moved safely and quickly.

Through alternate positioning in the pallet, the props secure each other against slipping.



The securing hook prevents the inner tube from slipping out and must be properly engaged for correct transportation procedure.



PERI Stacking Pallets are matched to suit truck loading dimensions. They can be lifted using the longitudinal as well as end sides.



For moving tables or towers, two transportation trolleys are positioned centrally on the narrow frame sides of the shoring, and lifted uniformly.

Project examples with MULTIPROP



Project examples with MULTIPROP



VARIOKIT and MULTIPROP system components formed the cost-effective basis for the form-shaping slab tables.



MULTIPROP Props carried the timber construction and facilitated the curved shape of the gridshell.



Inexpensive supporting structure consisting of MULTIPROP Props in combination with VARIOKIT system components.

Administration Building, Banco Ciudad de Buenos Aires, Argentina

The new administration building of the Banco Ciudad de Buenos Aires is dominated by a wave-shaped, 9,000 m² roof construction. The building complex bears the signature of the London-based architect Norman Foster.

A spatially designed PERI UP Flex Scaffold Construction along with MULTIFLEX Girder Slab Formwork formed horizontal working and support levels.

Using timber formers, the precisely-shaped formwork elements – on the basis of the VARIO system – were connected to a VARIOKIT raised formwork construction and MULTIPROP Shoring Towers to form large-sized movable table units.

Weald & Downland Museum, West Sussex, Great Britain

For the realization of the timber construction of this extraordinary roof support structure, the PERI scaffolding solution created optimal conditions for cost-effective and safe execution.

Over 200 MULTIPROP Props were used in a telescopic form in order to bring the “grid mat” – a network of timber profiles – into its final position and then secured in place. Due to the large adjustment range of the MULTIPROP Props, the multiple-curved shape of the gridshell was easily constructed. With PERI standard components, articulated connections on the obliquely positioned MULTIPROP Slab Props were realized.

Shipping and Service Centre Ganter, Furtwangen, Germany

The 2-storey hall extension – 65 m x 32 m and 12 m high – was a major challenge as the ongoing daily operations in the existing buildings were not allowed to be affected by the construction and demolition work in any way.

For the required enclosure of the order-picking area, PERI planned a self-supporting enclosure with system components taken from the VARIOKIT Engineering Construction Kit. The individual loads were carried by MULTIPROP Props. Wherever necessary, e.g. for supporting the pre-cast beams and slabs, the construction team used MULTIPROP Shoring Towers.



The RCS Rails of the RCS MP Landing Platform are clamped between two floor slabs by means of MULTIPROP Props.



MULTIPROP Props, used for large-sized SKYTABLE Slab Tables, facilitate faster cycles with a higher level of safety.



The PERI solution with MULTIPROP and MULTIFLEX, as well as for forming the circumferential balconies, served simultaneously as working scaffold.

Administration Building, Sparkasse Ulm, Germany

For the construction of the two new office buildings with a total of 9 floors respectively, jobsite logistics was a great challenge due to the tight, inner-city location. The use of VARIODECK Slab tables ensured rapid construction progress for the realization of the floor slabs. A closed, 2 m high side protection on the edge tables at the north side meant that a time-consuming and elaborate roofing construction for the directly adjacent underground car park was not necessary.

The RCS MP Landing Platform was used for moving and temporary storage of the slab tables and other materials. It can be positioned at any point on the building. The platform also provides anti-slip checkered plate decking and continuous side protection on the platform through LPS Side Mesh Barriers

Centene Plaza, Clayton, Missouri, United States

For the construction of the 17-storey office tower in Clayton near St. Louis, 53 SKYTABLEs were used. By means of coupled truss girders, slab tables up to 24.40 m long were created. With a width of 6.10 m, approx. 150 m² could be formed with one table.

Load transfer took place via MULTIPROP Props which were mounted on the truss girders with quick lowering devices. By connecting the MULTIPROP Props with frames, the slab table was also used for larger floor heights.

Residential and Office Building at the North Railway Station, Vienna, Austria

On the site of the former Vienna North Railway Station, around 10,000 apartments and 20,000 workplaces were realized in several stages of construction. The urban design concept for two 8-storey residential buildings with a total of 91 housing units featured well-equipped facilities including balconies and loggias, constructed using in-situ reinforced concrete.

For forming the balconies, PERI engineers relied on MULTIFLEX Girder Slab Formwork, supported by MULTIPROP Shoring Towers. As a result, the increased architectural concrete requirements could be met; in consultation with the site management, cantilevered slab formwork simultaneously served as end-to-end working scaffold.

MULTIPROP Single Props and System



Item no.	Weight kg
027288	10.200
027289	15.400
027290	19.500
027291	24.900
027305	34.700

MULTIPROP MP
MULTIPROP MP 120
MULTIPROP MP 250
MULTIPROP MP 350
MULTIPROP MP 480
MULTIPROP MP 625

Slab prop made of aluminium. Used as individual prop as well as in combination with MULTIPROP Frames MRK to form towers.

min. L	max. L
800	1200
1450	2500
1950	3500
2600	4800
4300	6250

Note

Approved by the German Building Authorities No. Z-8.312-824.

Technical Data

Permissible load: see PERI Design Tables.

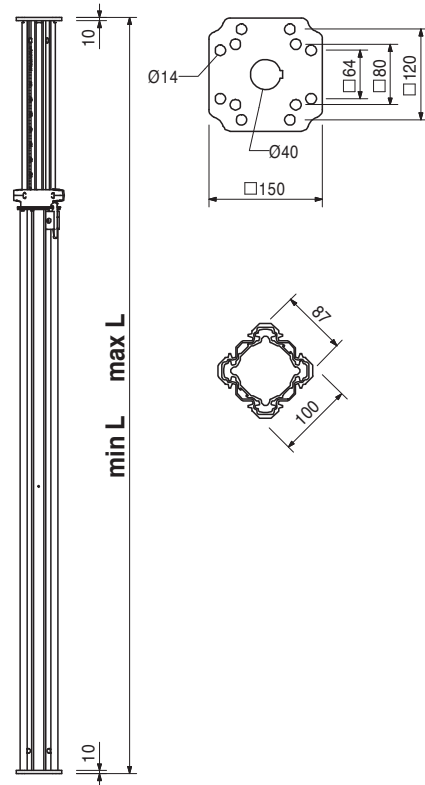
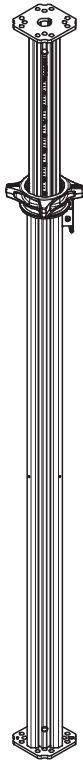

MULTIPROP Single Props and System

Item no.	Weight kg
028390	9.840
028400	10.100
028330	11.300
028340	14.000
028380	15.400
028350	16.300

MULTIPROP Frames MRK, Steel

Frame MRK 62.5

Frame MRK 75

Frame MRK 90

Frame MRK 120

Frame MRK 137.5

Frame MRK 150

Bracing frame for MULTIPROP. For connecting to outer and inner tube.

With captive wedge coupling.

L	X
545	625
670	750
820	900
1120	1200
1295	1375
1420	1500

Note

L = Loading Length

X = Axis Length

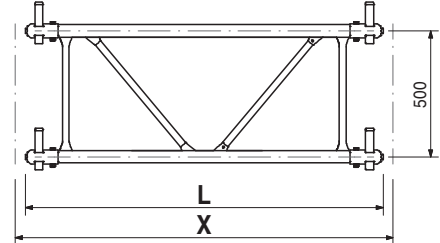
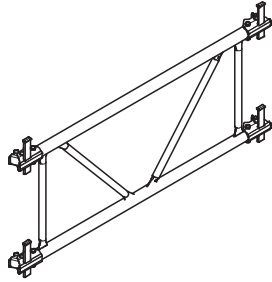

028460	11.600
028360	12.300
028470	12.500
028480	12.700
028490	13.900
028370	14.900

MULTIPROP Frames MRK, Alu

Frame MRK 201.5

Frame MRK 225

Frame MRK 230

Frame MRK 237

Frame MRK 266

Frame MRK 296

Bracing frame for MULTIPROP. For connecting to outer and inner tube.

With captive wedge coupling.

L	X
1935	2015
2170	2250
2220	2300
2290	2370
2580	2660
2880	2960

Note

L = Loading Length

X = Axis Length

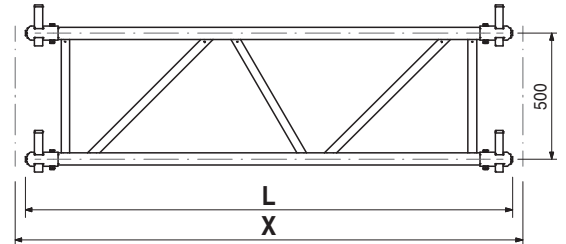
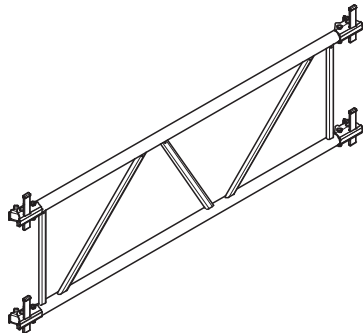

Item no.	Weight kg
107169	12.000
107170	18.000

MULTIPROP Platforms
MULTIPROP Platform 150 x 60
MULTIPROP Platform 225 x 60
 For assembly of a working scaffold.

Technical Data
 Permissible load up to 2.0 kN/m².

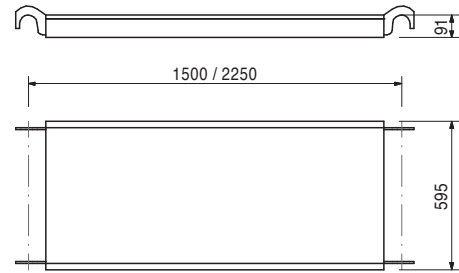
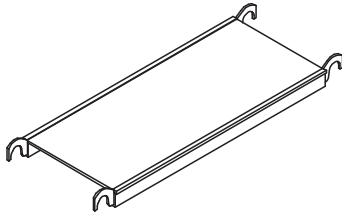

107171	12.500
107172	18.500

MULTIPROP Platforms with Hatch
MULTIPROP Platform 150 x 60 with Hatch
MULTIPROP Platform 225 x 60 with Hatch
 For assembly of a working scaffold. Self-locking hatch for access ladder.

Technical Data
 Permissible load up to 2.0 kN/m².

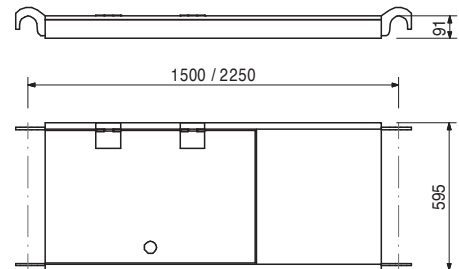
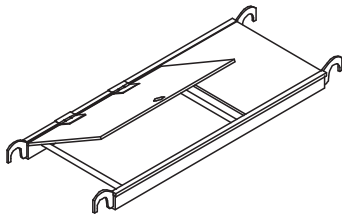

107173	9.000
--------	-------

Ladder 220 x 350, telescopic
 As access for MULTIPROP towers. Mounted to platform with hatch.

Technical Data
 Extension length 2.20 – 3.50 m.

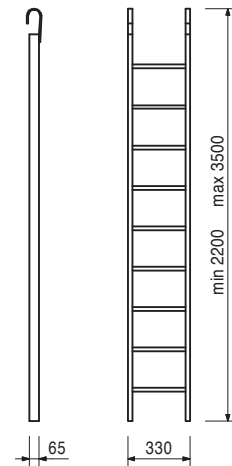
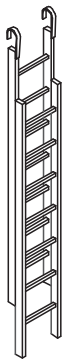

Item no.	Weight kg
022027	3.600

Wing Nut Spanner HD

For easy release of the Head Spindle HDK 45, the Head Spindle TR 110-80/55 and the MULTIPROP slab prop.

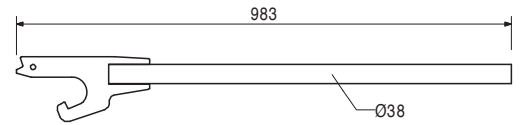
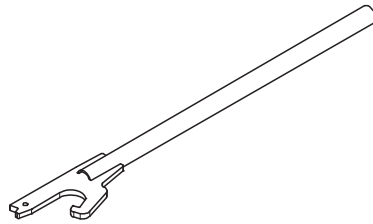

027310	8.900
--------	-------

Base MP 50

For use with slab props with an end plate thickness of 6 – 10 mm. With clamped quick-release fastener.

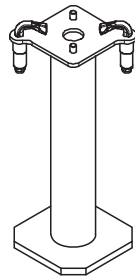

Note

Permissible load: see PERI Design Tables.

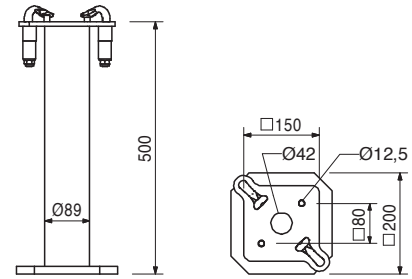

027297	8.730
--------	-------

Tilting Forkhead MKK

For tilt-resistant support of one or two GT 24 or VT 20 Girders. Can be pivoted by 3° in all directions. With clamped quick-release fastener.

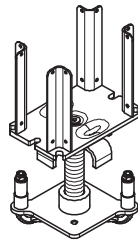

Technical Data

Separate design information on request.

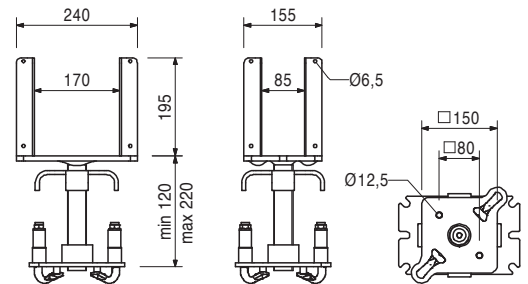

027296	6.220
--------	-------

Tilting Base MKF

For use on inclined assembly areas. Can be pivoted by 3° in all directions. With clamped quick-release fastener.

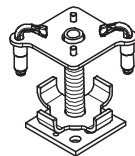

Technical Data

Maximum permissible load 60 kN.

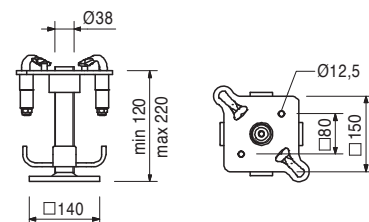

Item no. Weight kg

027298 1.930
027299 1.930

Scaffold Tube Couplers
Scaffold Tube Coupler MG-A/C
Scaffold Tube Coupler MG-B/D

For connecting Scaffold Tubes \varnothing 48 mm to the MULTIPROP MP slab props.

Note
Coupler not swivelling.

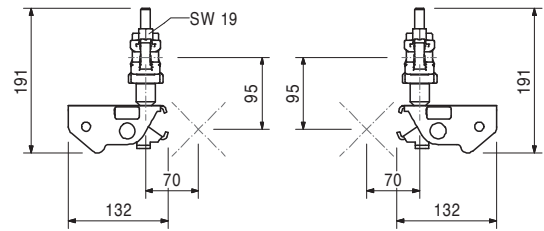
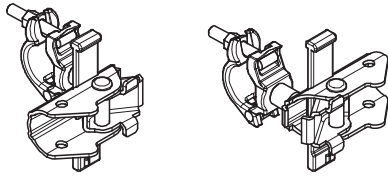

028000 9.170

Universal Tripod, galv.

Erection aid for slab props with \varnothing 48 – 120 mm and 120 x 120 mm. Can also be used in combination with MULTIPROP MP slab props and all slab props with Base MP 50.

Note
Only use as erection aid!

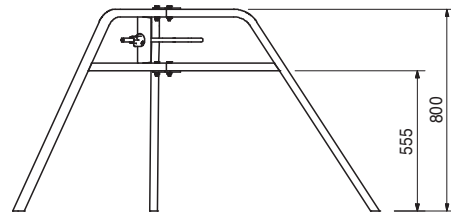
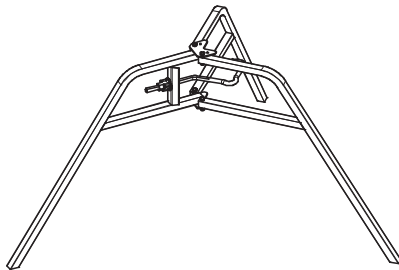

027301 1.020

Connector MPV-2

For connecting 2 MULTIPROP slab props.

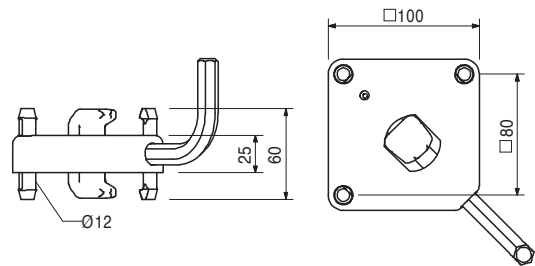
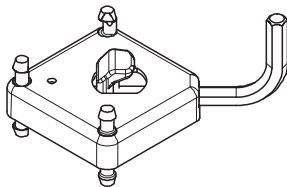

111142 0.082

MULTIPROP Bolt with Nut

For connecting 2 MULTIPROP slab props, for connecting compression Brace Head MP/SRU and for the assembly of accessories on the Alu Beam MPB 24.

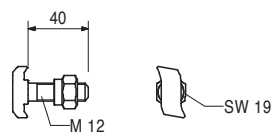

MULTIPROP Single Props and System



Item no.	Weight kg
027302	2.100

MULTIPROP Strap SRZ U100 – U140
 For fixing Steel Walers SRZ and SRU, Profile U100 to U140 on MULTIPROP slab props.

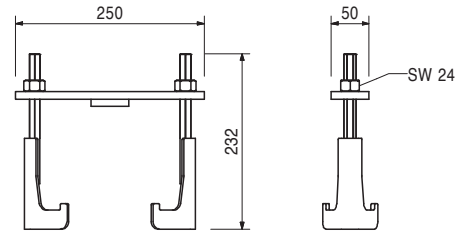
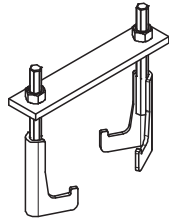

129565	1.680
--------	-------

Brace Connector MPR
 For connecting push-pull props to the MP-System.

Complete with
 1 pc. 027170 Pin \varnothing 16 x 42, galv.
 1 pc. 018060 Cotter Pin 4/1, galv.
 2 pc. 129560 Collar Pin \varnothing 12
 2 pc. 127322 Cotter Pin 3, 2/2, galv.

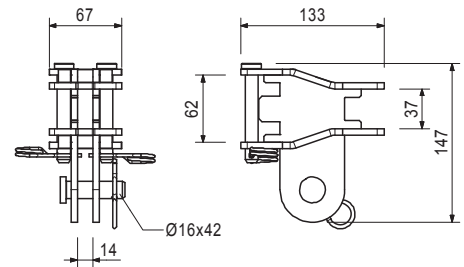
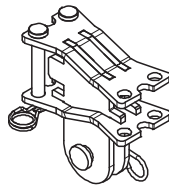

107161	3.050
--------	-------

Compression Brace Head MP/SRU
 As connecting element between MULTIPROP slab props and Steel Waler SRU/SRZ.

Note
 Separate design information on request.
Technical Data
 Permissible load-bearing capacity 70 kN.

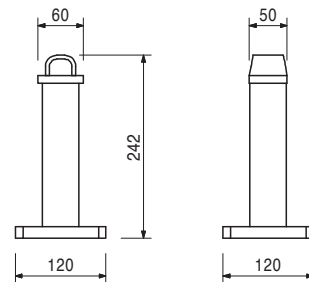
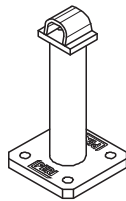

104031	0.462
018060	0.030
111142	0.082

Accessories
Fitting Pin \varnothing 21 x 120
Cotter Pin 4/1, galv.
MULTIPROP Bolt with Nut

Item no.	Weight kg
107160	3.960

Connector MP-SRU

As compensation element between the Prop Head MP/SRU and inclined positioned Steel Waler SRU.

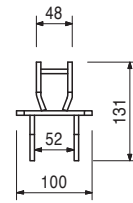
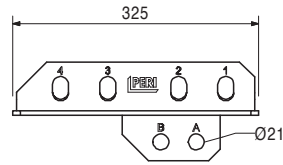
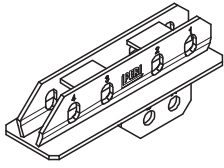

Accessories

104031	0.462
018060	0.030

Fitting Pin Ø 21 x 120
Cotter Pin 4/1, galv.

104031	0.462
--------	-------

Fitting Pin Ø 21 x 120
For different connections.

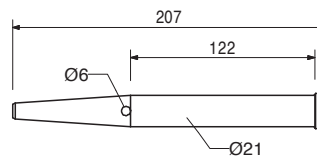
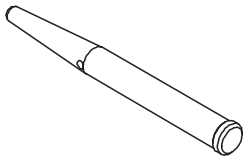

Accessories

018060	0.030
--------	-------

Cotter Pin 4/1, galv.

105400	0.330
--------	-------

Pin Ø 20 x 140, galv.
For different connections.

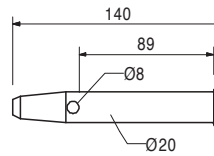
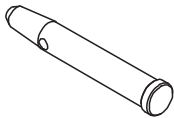

Accessories

018060	0.030
--------	-------

Cotter Pin 4/1, galv.

018060	0.030
--------	-------

Cotter Pin 4/1, galv.



MULTIPROP Single Props and System



Item no.	Weight kg
019200	162.000

Trolley with Winch

For moving towers and tables with MULTIPROP, Flex, Flex Plus and PD 8 with appropriate support for the system.

Note

Follow Instructions for Use!

Technical Data

Permissible load-bearing capacity 1.0 t.

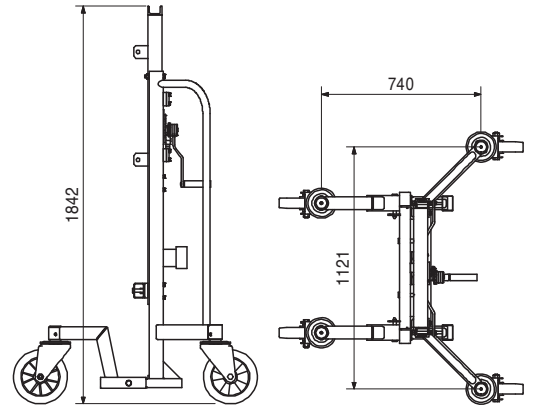
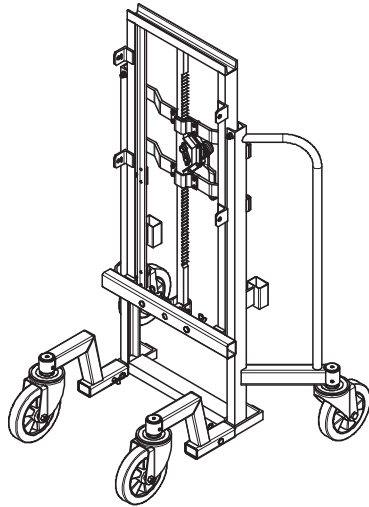

Accessories

118114	14.200
118605	21.500
117954	21.200
118115	11.000

Connector MP – Trolley

Connector Rosett – Trolley

Connector Rosett Plus – Trolley

Connector PD 8 – Trolley

118114	14.200
--------	--------

Connector MP – Trolley

For moving MULTIPROP towers with Trolley with Winch.

Note

Consisting of 2 parts:
Support left and right.

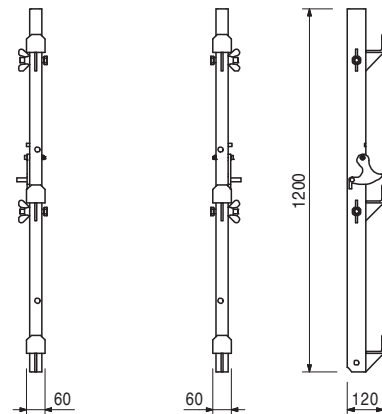
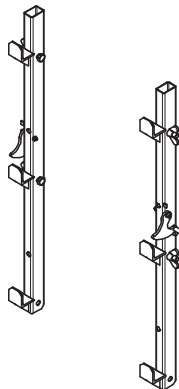

Item no.	Weight kg	
		Alu Beams MPB 24
079300	24.000	Alu Beam MPB 24 l = 3.00 m
079360	28.800	Alu Beam MPB 24 l = 3.60 m
079420	33.700	Alu Beam MPB 24 l = 4.20 m
079480	38.500	Alu Beam MPB 24 l = 4.80 m
079540	43.300	Alu Beam MPB 24 l = 5.40 m
079600	48.100	Alu Beam MPB 24 l = 6.00 m
		Aluminium main beam for the MULTIPROP system.

L
2998
3598
4198
4798
5398
5998

Technical Data
 perm. Q = 50 kN
 perm. A = 80 kN
 perm. M = 15 kNm

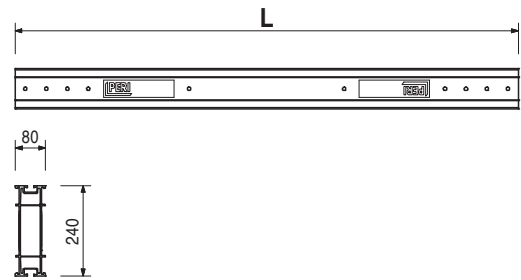
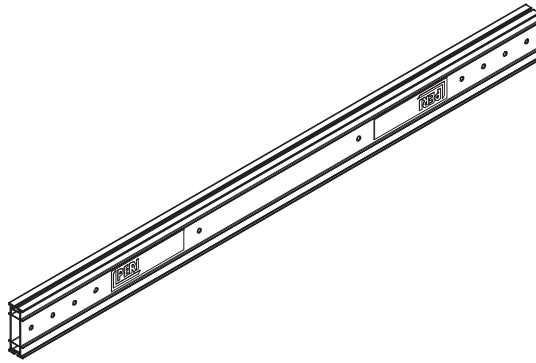

107348	9.590	Coupling MPB 24 For connecting the Alu Beam MPB 24.
--------	-------	---

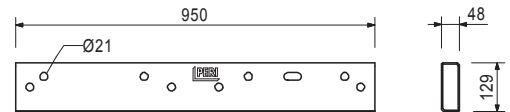
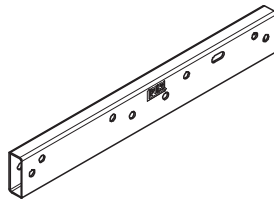

Accessories		
105400	0.330	Pin Ø 20 x 140, galv.
104031	0.462	Fitting Pin Ø 21 x 120
018060	0.030	Cotter Pin 4/1, galv.

108339	0.203	Quick Strap MPB 24/GT 24 For assembly of GT 24 Girders on the Alu Beam MPB 24.
--------	-------	--

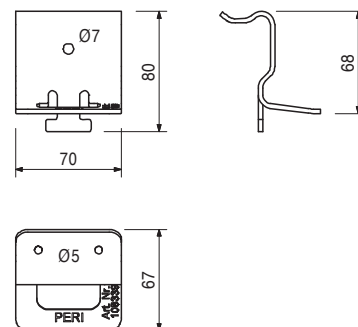
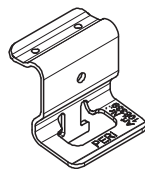

Accessories		
018280	1.000	Double Head Nail, l = 65 mm

Item no.	Weight kg
111000	0.815

Tension Strap MPB 24 / GT 24

For fixing of GT 24 Girders on the Alu Beam MPB 24.

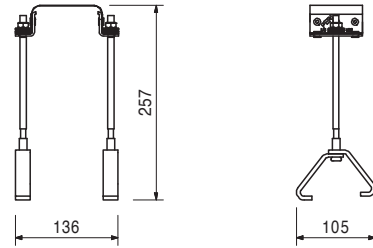
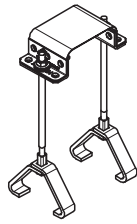

107820	0.057
--------	-------

Strap MPB 24

For fixing Alu Beam MPB 24 to the MULTIPROP prop or mounting the GT 24 Girders on the Alu Beam MPB 24.

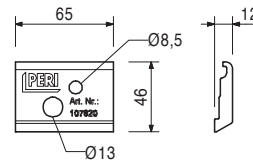

Accessories

111142	0.082
--------	-------

MULTIPROP Bolt with Nut

108213	2.590
--------	-------

Brace Connector MPB 24

For connecting push-pull props or bracings to Aluminium Beam MPB 24.

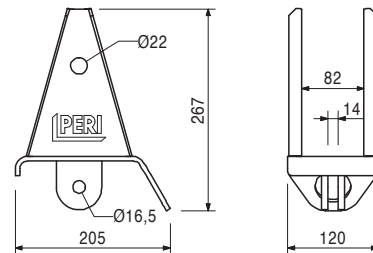
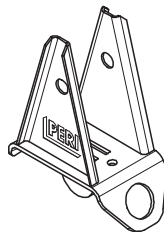

Accessories

104031	0.462
018060	0.030

Fitting Pin Ø 21 x 120

Cotter Pin 4/1, galv.

MULTIPROP Single Props and System



Item no.	Weight kg
104131	3.940

Guardrail Holder SRU/SRZ

For assembling a guardrail to the Steel Walers SRU and SRZ, Profile U100 to U140.

Complete with

2 pc. 105400 Pin Ø 20 x 140, galv.
2 pc. 018060 Cotter Pin 4/1, galv.

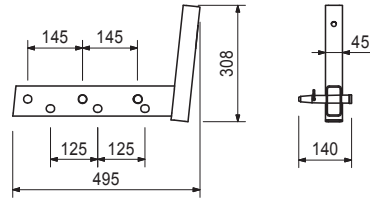
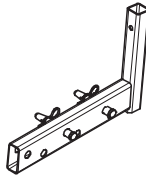

Accessories

116292	4.730
061260	6.150

Guardrail Post HSGP-2

Guardrail Post SGP

116292	4.730
--------	-------

Guardrail Post HSGP-2

As guardrail for different systems.

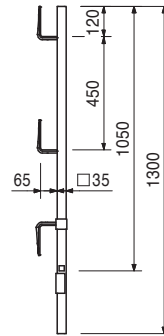

PERI International

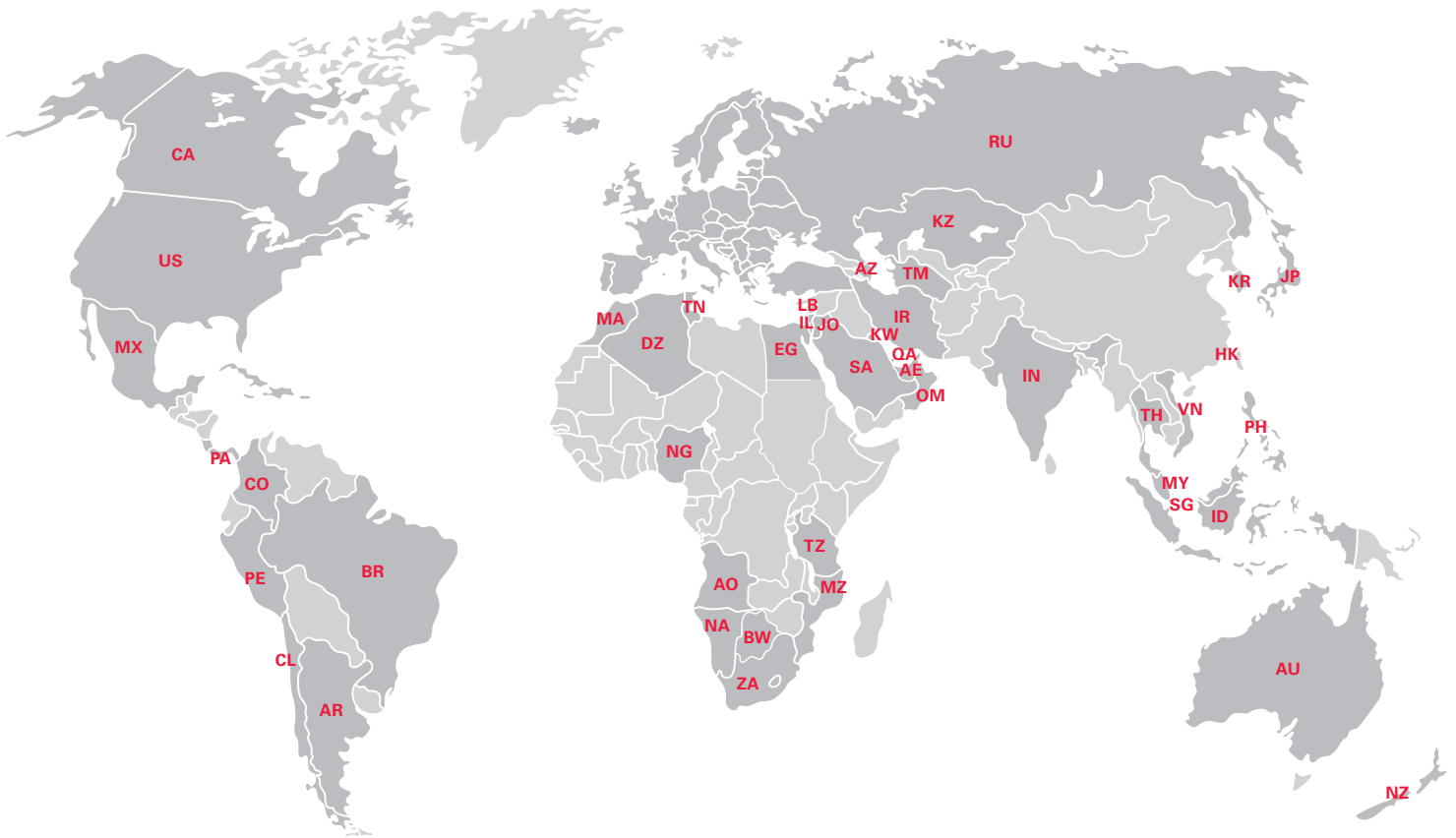

North America

- CA** Canada
PERI Formwork Systems, Inc.
www.peri.ca
- MX** Mexico
PERI Cimbras y Andamios, S.A. de C.V.
www.peri.com.mx
- PA** Panama
PERI Panama Inc.
www.peri.com.pa
- US** USA
PERI Formwork Systems, Inc.
www.peri-usa.com

South America

- AR** Argentina
PERI S.A.
www.peri.com.ar
- BR** Brazil
PERI Formas e Escoramentos Ltda.
www.peribrasil.com.br
- CL** Chile
PERI Chile Ltda.
www.peri.cl
- CO** Colombia
PERI S.A.S.
www.peri.com.co
- PE** Peru
PERI Peruana S.A.C.
www.peri.com.pe

Africa

- AO** Angola
Pericofragens, Lda.
www.peri.pt
- DZ** Algeria
S.A.R.L. PERI
www.peri.dz
- BW** Botswana
PERI (Proprietary) Limited
www.peri.co.bw
- EG** Egypt
Egypt Branch Office
www.peri.com.eg
- MA** Morocco
PERI S.A.
www.peri.ma
- MZ** Mozambique
PERI (Pty.) Ltd.
www.peri.co.mz
- NA** Namibia
PERI (Pty.) Ltd.
www.peri.na
- NG** Nigeria
PERI Nigeria Ltd.
www.peri.ng
- TN** Tunisia
PERI S.A.U.
www.peri.es
- TZ** Tanzania
PERI Formwork and Scaffolding Ltd
www.peritanzania.com
- ZA** South Africa
PERI Formwork Scaffolding (Pty) Ltd
www.peri.co.za

Asia

- AE** United Arab Emirates
PERI (L.L.C.)
www.perime.com
- AZ** Azerbaijan
PERI Representative Office
www.peri.com.tr
- HK** Hong Kong
PERI (Hong Kong) Limited
www.perihk.com
- ID** Indonesia
PT Beton Perkasa Wijaksana
www.betonperkasa.com
- IL** Israel
PERI F.E. Ltd.
www.peri.co.il
- IN** India
PERI (India) Pvt Ltd
www.peri.in
- IR** Iran
PERI Persa. Ltd.
www.peri.ir
- JO** Jordan
PERI GmbH – Jordan
www.peri.com
- JP** Japan
PERI Japan K.K.
www.perijapan.jp
- KR** Korea
PERI (Korea) Ltd.
www.perikorea.com
- KW** Kuwait
PERI Kuwait W.L.L.
www.peri.com.kw
- KZ** Kazakhstan
TOO PERI Kazakhstan
www.peri.kz
- LB** Lebanon
PERI Lebanon Sarl
lebanon@peri.de
- MY** Malaysia
PERI Formwork Malaysia Sdn. Bhd.
www.perimalaysia.com
- OM** Oman
PERI (L.L.C.)
www.perime.com
- PH** Philippines
PERI-Asia Philippines, INC.
www.peri.com.ph
- QA** Qatar
PERI Qatar LLC
www.peri.qa
- SA** Saudi Arabia
PERI Saudi Arabia Ltd.
www.peri.com.sa
- SG** Singapore
PERI Asia Pte Ltd
www.periasia.com
- TM** Turkmenistan
PERI Sanayi
www.peri.com.tr
- TH** Thailand
Peri (Thailand) Co., Ltd.
www.peri.co.th
- VN** Vietnam
PERI ASIA PTE LTD
www.peri.com.vn



PERI GmbH
Formwork Scaffolding Engineering
Rudolf-Diesel-Strasse 19
89264 Weissenhorn
Germany
Tel. +49 (0)7309.950-0
Fax +49 (0)7309.951-0
info@peri.com
www.peri.com



Oceania

AU Australia
PERI Australia Pty. Ltd.
www.periaus.com.au

NZ New Zealand
PERI Australia Pty. Limited
www.peri.co.nz

Europe

AL Albania
PERI Kalıp ve İskeleleri
www.peri.com.tr

AT Austria
PERI Ges.mbH
www.peri.at

BA Bosnia and Herzegovina
PERI oplate i skele d.o.o
www.peri.com.hr

BE Belgium
N.V. PERI S.A.
www.peri.be

BG Bulgaria
PERI Bulgaria EOOD
www.peri.bg

BY Belorussia
IOOO PERI
www.peri.by

CH Switzerland
PERI AG
www.peri.ch

CZ Czech Republic
PERI spol. S r.o.
www.peri.cz

DE Germany
PERI GmbH
www.peri.de

DK Denmark
PERI Danmark A/S
www.peri.dk

EE Estonia
PERI AS
www.peri.ee

ES Spain
PERI S.A.U.
www.peri.es

FI Finland
PERI Suomi Ltd. Oy
www.perisuomi.fi

FR France
PERI S.A.S.
www.peri.fr

GB United Kingdom
PERI Ltd.
www.peri.ltd.uk

GR Greece
PERI Hellas Ltd.
www.perihellas.gr

HR Croatia
PERI oplate i skele d.o.o.
www.peri.com.hr

HU Hungary
PERI Kft.
www.peri.hu

IR Ireland
Siteserv Access & Formwork
www.siteservaccess.ie

IS Iceland
Armar ehf.
www.armor.is

IT Italy
PERI S.p.A.
www.peri.it

LT Lithuania
PERI UAB
www.peri.lt

LU Luxembourg
N.V. PERI S.A.
www.peri.lu

LV Latvia
PERI SIA
www.peri-latvija.lv

NL Netherlands
PERI B.V.
www.peri.nl

NO Norway
PERI Norge AS
www.peri.no

PL Poland
PERI Polska Sp. z o.o.
www.peri.com.pl

PT Portugal
Pericofragens Lda.
www.peri.pt

RO Romania
PERI România SRL
www.peri.ro

RS Serbia
PERI oplate d.o.o.
www.peri.rs

RU Russia
OOO PERI
www.peri.ru

SE Sweden
PERI Sverige AB
www.periform.se

SI Slovenia
PERI oplate i skele d.o.o
www.peri.com.hr

SK Slovakia
PERI spol. s. r.o.
www.peri.sk

TR Turkey
PERI Sanayi ve Ticaret Ltd.
www.peri.com.tr

UA Ukraine
TOW PERI
www.peri.ua

**The optimal System
for every Project and
every Requirement**



Wall Formwork



Column Formwork



Slab Formwork



Climbing Systems



Bridge Formwork



Tunnel Formwork



Shoring Systems



Construction Scaffold



Facade Scaffold



Industrial Scaffold



Access



Protection Scaffold



Safety Systems



System-Independent Accessories



Services



PERI GmbH
Formwork Scaffolding Engineering
 Rudolf-Diesel-Strasse 19
 89264 Weissenhorn
 Germany
 Tel. +49 (0)7309.950-0
 Fax +49 (0)7309.951-0
 info@peri.com
 www.peri.com